



**ResMed**

**Lumis™ series**

VPAP S

VPAP ST



User guide  
English

## Welcome

The Lumis™ 100 VPAP S, Lumis 100 VPAP ST and Lumis 150 VPAP ST are bilevel positive airway pressure devices.

### WARNING

- Read this entire guide before using the device.
- Use the device according to the intended use provided in this guide.
- The advice provided by your prescribing doctor should be followed ahead of the information provided in this guide.

## Indications for use

### Lumis 100 VPAP S

The Lumis 100 VPAP S device is indicated to provide non-invasive ventilation for patients weighing more than 13 kg with respiratory insufficiency or obstructive sleep apnoea (OSA). It is intended for home and hospital use.

The humidifier is intended for single patient use in the home environment and re-use in a hospital/institutional environment.

### Lumis 100 VPAP ST

The Lumis 100 VPAP ST device is indicated to provide non-invasive ventilation for patients weighing more than 13 kg with respiratory insufficiency or obstructive sleep apnoea (OSA). It is intended for home and hospital use.

The humidifier is intended for single patient use in the home environment and re-use in a hospital/institutional environment.

### Lumis 150 VPAP ST

The Lumis 150 VPAP ST device is indicated to provide non-invasive ventilation for patients weighing more than 13 kg or more than 30 kg in iVAPS mode with respiratory insufficiency or obstructive sleep apnoea (OSA). It is intended for home and hospital use.

The humidifier is intended for single patient use in the home environment and re-use in a hospital/institutional environment.

## Contraindications

Positive airway pressure therapy may be contraindicated in some patients with the following pre-existing conditions:

- severe bullous lung disease
- pneumothorax or pneumomediastinum
- pathologically low blood pressure, particularly if associated with intravascular volume depletion
- dehydration
- cerebrospinal fluid leak, recent cranial surgery, or trauma.

## Adverse effects

You should report unusual chest pain, severe headache, or increased breathlessness to your prescribing physician. An acute upper respiratory tract infection may require temporary discontinuation of treatment.

The following side effects may arise during the course of therapy with the device:

- drying of the nose, mouth, or throat
- nosebleed
- bloating
- ear or sinus discomfort
- eye irritation
- skin rashes.

## At a glance

The Lumis includes the following:

- Device
- HumidAir™ humidifier (if supplied)
- Air tubing
- Power supply unit
- Travel bag
- SD card (already inserted).

Contact your care provider for a range of accessories available for use with the device including:

- Air tubing (heated and non-heated): ClimateLineAir™, ClimateLineAir Oxy, SlimLine™, Standard
- HumidAir humidifier
- Side cover for use without the humidifier
- Filter: Hypoallergenic filter, standard filter
- Air10™ DC/DC converter (12V/24V)
- SD card reader
- Air10 oximeter adapter
- Air10 USB adapter
- Power Station II
- Air10 tubing elbow

## About your device

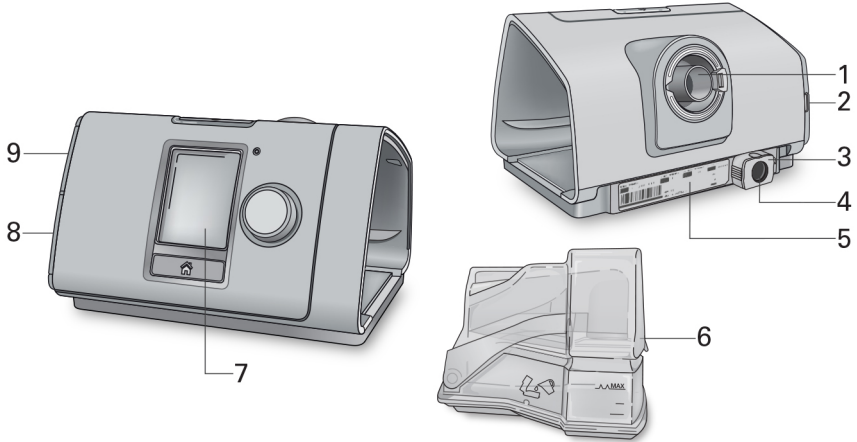

- 1 Air outlet
- 2 Air filter cover
- 3 Retention clip
- 4 Power inlet
- 5 Serial number and device number

- 6 HumidAir humidifier
- 7 Screen
- 8 Adapter cover
- 9 SD card cover

## About the control panel



Start/Stop button

Press to start/stop therapy.  
Press and hold for three seconds to enter power save mode.



Dial

Turn to navigate the menu and press to select an option.  
Turn to adjust a selected option and press to save your change.



Home button

Press to return to the Home screen.

Different icons may be displayed on the screen at different times including:



Ramp Time



Wireless signal strength (green)



Humidity



Wireless transfer not enabled (grey)



Humidifier warming



No wireless connection



Humidifier cooling



Airplane Mode

## Setup

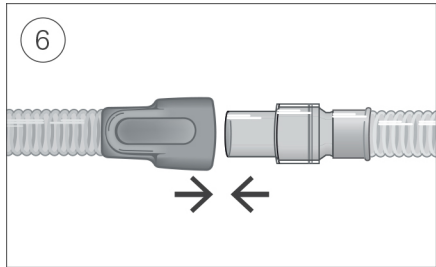
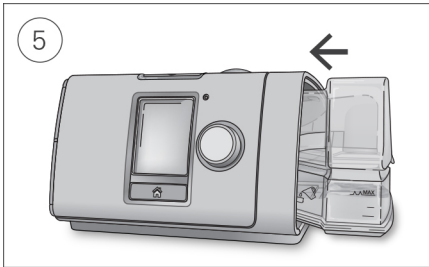
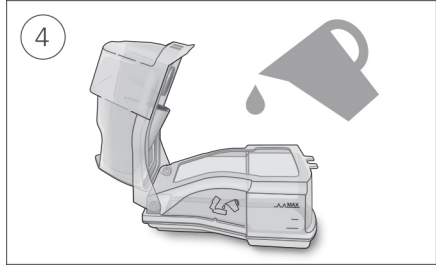
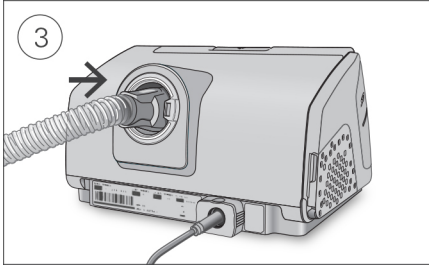
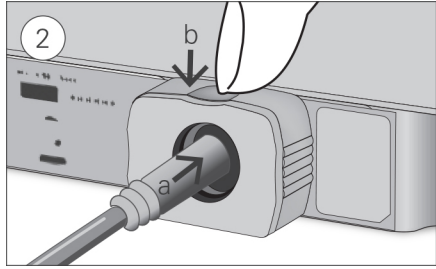
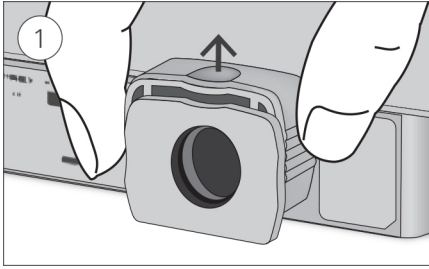

### CAUTION

**Do not overfill the humidifier as water may enter the device and air tubing.**

1. With the device on a stable level surface, grip the retention clip on the back of the device and pull up to open. Note: The retention clip is shown in the open position.
2. (a) Plug the power connector into the device power inlet then (b) push down the retention clip to secure in place. Connect one end of the power cord into the power supply unit and the other end into the power outlet.
3. Connect the air tubing firmly to the air outlet located on the rear of the device.
4. Open the humidifier and fill it with water up to the maximum water level mark.  
Do not fill the humidifier with hot water.
5. Close the humidifier and insert it into the side of the device.
6. Connect the free end of the air tubing firmly onto the assembled mask.  
See the mask user guide for detailed information.

Recommended masks are available on [www.resmed.com](http://www.resmed.com).

# Starting therapy

1. Fit your mask.
2. Press Start/Stop or breathe normally if SmartStart™ is enabled.

You will know that therapy is on when the **Monitoring** screen is displayed.

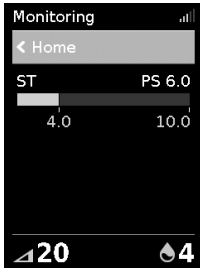

The pressure bar shows the inspiratory and expiratory pressures in green. The green bar will expand and contract as you breathe in and out.

The screen will go black automatically after a short period of time. You can press Home or the dial to turn it back on. If power is interrupted during therapy, the device will automatically restart therapy when power is restored.

The Lumis device has a light sensor that adjusts the screen brightness based on the light in the room.

# Stopping therapy

1. Remove your mask.
2. Press Start/Stop or if SmartStart is enabled, therapy will stop automatically after a few seconds.

**Note:** If Confirm Stop is enabled, a message is displayed asking if you want to stop therapy. Turn the dial to select **Yes** and then press the dial to stop therapy.

Once therapy has stopped, the **Sleep Report** gives you a summary of your therapy session.



**Usage hours**—Indicates the number of hours of therapy you received last session.

**Mask Seal**—Indicates how well your mask sealed:

😊 Good mask seal.

☹️ Needs adjusting, see Mask Fit.

**Humidifier**—Indicates if your humidifier is working properly:

😊 Humidifier working.

☹️ Humidifier might be faulty, contact your care provider.

If set by your care provider, you will also see:

**Events per hour**—Indicates the number of apnoeas and hypopnoeas experienced per hour.

**More Info**—Turn the dial to scroll down to view more detailed usage data.

## Power save mode

Your Lumis device records your therapy data. In order to allow it to transmit the data to your care provider, you should not unplug the device. However, you can put it into power save mode to save electricity.

### To enter power save mode:

- Press and hold Start/Stop for three seconds.  
The screen goes black.

### To exit power save mode:

- Press Start/Stop once.  
The Home screen is displayed.

## My Options

Your Lumis device has been set up for your needs by your care provider, but you may find you want to make small adjustments to make your therapy more comfortable.

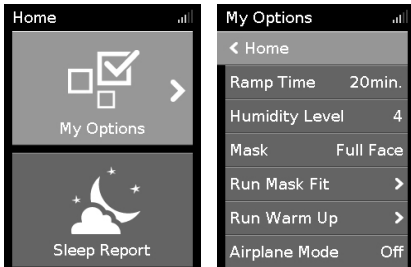

Highlight **My Options** and press the dial to see your current settings. From here, you can personalise your options.

## Ramp Time

Designed to make the beginning of therapy more comfortable, Ramp Time is the period during which the pressure increases from a low start pressure to the prescribed treatment pressure.

You can set your Ramp Time to Off or between 5 to 45 minutes.

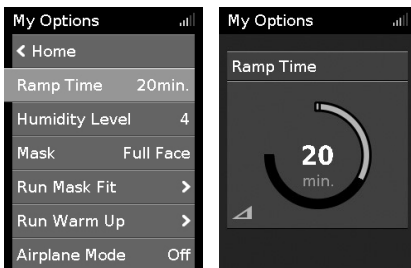

### To adjust Ramp Time:

1. In **My Options**, turn the dial to highlight **Ramp Time** and then press the dial.
2. Turn the dial to adjust the ramp time to your preferred setting and press the dial to save the change.

## Ramp Down

Ramp Down is intended to make stopping therapy more comfortable by reducing your pressure over a fixed 15 minute period. This option will only be available to you via your care provider.



### To enable Ramp Down:

1. In **My Options**, turn the dial to highlight **Ramp Down** and then press the dial.
2. Turn the dial to select **On** and then press the dial to save the change.

### To start Ramp Down:

1. Press the Start/Stop button.

### To start Ramp Down:

1. Press the Start/Stop button.
2. Follow on-screen instructions.

The Ramp Down icon  and time remaining will be displayed at the bottom left of the screen.

Once Ramp Down is complete, the device will continue to run at low pressure. To stop therapy at any time, press Start/Stop.

**Note:** If Confirm Stop is enabled, a message is displayed asking if you want to start Ramp Down. Turn the dial to select **Yes** and then press the dial to start Ramp Down.

## Humidity Level

The humidifier moistens the air and is designed to make therapy more comfortable. If you are getting a dry nose or mouth, turn up the humidity. If you are getting any moisture in your mask, turn down the humidity.

You can set the Humidity Level to Off or between 1 and 8, where 1 is the lowest humidity setting and 8 is the highest humidity setting.



### To adjust the Humidity Level:

1. In **My Options**, turn the dial to highlight **Humidity Level** and then press the dial.
2. Turn the dial to adjust the humidity level and press the dial to save the change.

If you continue to get a dry nose or mouth, or moisture in your mask, consider using ClimateLineAir heated air tubing. ClimateLineAir together with Climate Control delivers more comfortable therapy.



## Mask Fit

Mask Fit is designed to help you assess and identify possible air leaks around your mask.



### To check Mask Fit:

1. Fit the mask as described in the mask user guide.
2. In **My Options**, turn the dial to highlight **Run Mask Fit** and then press the dial.  
The device starts blowing air.
3. Adjust the mask, mask cushion and headgear until you get a **Good** result.

To stop Mask Fit, press the dial or Start/Stop. If you are unable to get a good mask seal, talk to your care provider.

## More options

There are some more options on your device which you can personalise.

<b>Mask</b>	This option shows your mask type setting. If you use more than one type of mask, adjust this setting when switching between masks.
<b>Run Warm Up</b>	This option allows you to pre-heat the water before starting therapy, so that the air is not cold or dry at the beginning of therapy.
<b>Ramp Down*</b>	This option is intended to make stopping therapy more comfortable by reducing your pressure over a fixed 15 minute period.
<b>Leak Alert*</b>	When Leak Alert is enabled, the device beeps if the mask leaks too much air or if you remove the mask during therapy.
<b>SmartStart*</b>	When SmartStart is enabled, therapy starts automatically when you breathe into your mask. When you remove your mask, it stops automatically after few seconds.

\*When enabled by your care provider.

## Caring for your device

It is important that you regularly clean your Lumis device to make sure you receive optimal therapy. The following sections will help you with disassembling, cleaning, checking and reassembling your device.

### **WARNING**

Regularly clean your tubing assembly, humidifier and mask to receive optimal therapy and to prevent the growth of germs that can adversely affect your health.

## Disassembling

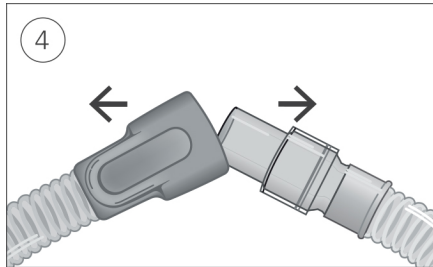
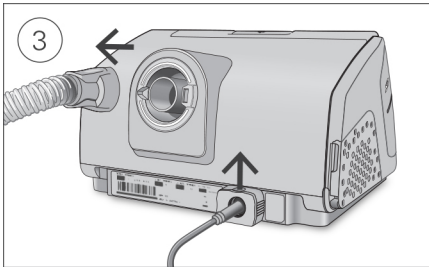
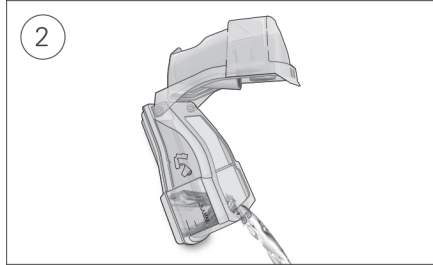
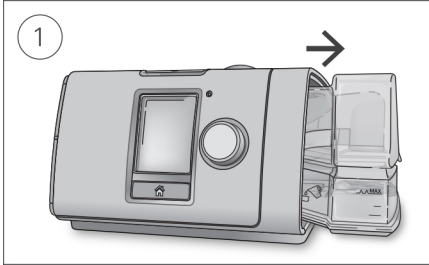

1. Hold the humidifier at the top and bottom, press it gently and pull it away from the device.
2. Open the humidifier and discard any remaining water.
3. Hold the cuff of the air tubing and gently pull it away from the device.  
Grip the retention clip and pull up to release the power cord.
4. Hold both the cuff of the air tubing and the swivel of the mask, then gently pull apart.

## Cleaning

You should clean the device weekly as described. Refer to the mask user guide for detailed instructions on cleaning your mask.

1. Wash the humidifier and air tubing in warm water using mild detergent.
2. Rinse the humidifier and air tubing thoroughly and allow to dry out of direct sunlight and/or heat.
3. Wipe the exterior of the device with a damp cloth and mild detergent.

### Notes:

- The humidifier may be washed in a dishwasher on the delicate or glassware cycle (top shelf only). It should not be washed at temperatures higher than 65°C.
- Do not wash the air tubing in a dishwasher or washing machine.
- Empty the humidifier daily and wipe it thoroughly with a clean, disposable cloth. Allow to dry out of direct sunlight and/or heat.

## Checking

You should regularly check the humidifier, air tubing and the air filter for any damage.

1. Check the humidifier:
  - Replace it if it is leaking or has become cracked, cloudy or pitted.
  - Replace it if the seal is cracked or torn.
  - Remove any white powder deposits using a solution of one part household vinegar to 10 parts water.
2. Check the air tubing and replace it if there are any holes, tears or cracks.
3. Check the air filter and replace it at least every six months. Replace more often if there are any holes or blockages by dirt or dust.

**To replace the air filter:**

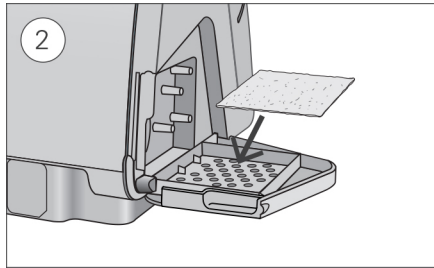
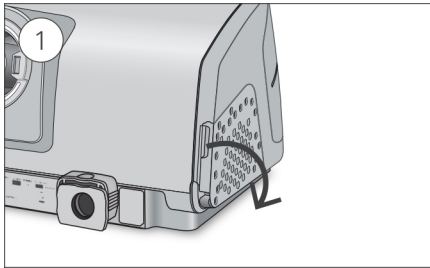

1. Open the air filter cover and remove the old air filter.  
The air filter is not washable or reusable.
2. Place a new air filter onto the air filter cover and then close it.  
Make sure the air filter is fitted at all times to prevent water and dust from entering the device.

## Reassembling

When the humidifier and air tubing are dry, you can reassemble the parts.

1. Connect the air tubing firmly to the air outlet located on the rear of the device.
2. Open the humidifier and fill it with room temperature water up to the maximum water level mark.
3. Close the humidifier and insert it into the side of the device.
4. Connect the free end of the air tubing firmly onto the assembled mask.

# Therapy data

Your Lumis device records your therapy data for you and your care provider so they can view and make changes to your therapy if required. The data is recorded and then transferred to your care provider wirelessly, if a wireless network is available, or via an SD card.

## Data transmission

Your Lumis device has the capability of wireless communication so that your therapy data can be transmitted to your care provider to improve the quality of your treatment. This is an optional feature that will only be available if you choose to benefit from it and if a wireless network is available. It also allows your care provider to update your therapy settings in a more timely manner or upgrade your device software to ensure you receive the best therapy possible.

The data is usually transmitted after therapy has stopped. In order to make sure that your data is transferred, leave your device connected to the mains power at all times and make sure that it is not in Airplane Mode.

### Notes:

- Therapy data might not be transmitted if you use it outside of the country or region of purchase.
- Wireless communication depends on network availability.
- Devices with wireless communication might not be available in all regions.

## SD card

An alternative way for your therapy data to be transferred to your care provider is via the SD card. Your care provider may ask you to send the SD card by mail or to bring it in. When instructed by your care provider, remove the SD card.

Do not remove the SD card from the device when the SD light is flashing.

### To remove the SD card:

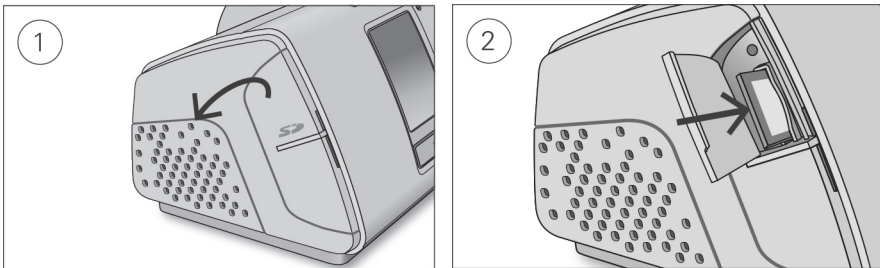

1. Open the SD card cover.
2. Push in the SD card to release it. Remove the SD card from the device.  
Place the SD card in the protective folder and send it back to your care provider.

For more information on the SD card refer to the SD card protective folder provided with your device.

**Note:** The SD card should not be used for any other purpose.

# Travelling

You can take your Lumis device with you wherever you go. Just keep the following in mind:

- Use the travel bag provided to prevent damage to the device.
- Empty the humidifier and pack it separately in the travel bag.
- Make sure you have the appropriate power cord for the region you are travelling to. For information on purchasing, contact your care provider.
- If you are using an external battery, you should turn off the humidifier in order to maximise the life of your battery. Do this by turning the **Humidity Level** to Off.

## Travelling by plane

Your Lumis device may be taken on board as carry-on luggage. Medical devices do not count toward your carry-on luggage limit.

You can use your Lumis device on a plane as it meets the Federal Aviation Administration (FAA) requirements. Air travel compliance letters can be downloaded and printed from [www.resmed.com](http://www.resmed.com).

When using the device on a plane:

- Make sure the humidifier is completely empty and inserted into your device. The device will not work without the humidifier inserted.
- Turn on **Airplane Mode**.

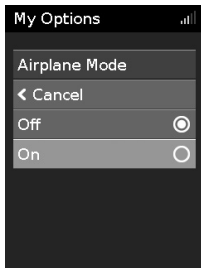

### To turn on Airplane Mode:

1. In **My Options**, turn the dial to highlight **Airplane Mode** and then press the dial.
2. Turn the dial to select **On** and then press the dial to save the change.

The Airplane Mode icon ✈️ is displayed at the top right of the screen.

## CAUTION



Do not use the device with water in the humidifier on a plane due to the risk of inhalation of water during turbulence.

# Troubleshooting

If you have any problems, have a look at the following troubleshooting topics. If you are not able to fix the problem, contact your care provider or ResMed. Do not try to open the device.



## General troubleshooting

Problem/possible cause	Solution
<b>Air is leaking from around my mask</b> Mask may be fitted incorrectly.	Make sure your mask is fitted correctly. See your mask user guide for fitting instructions or use the Mask Fit function to check your mask fit and seal.
<b>I am getting a dry or blocked nose</b> Humidity level may be set too low.	Adjust the Humidity Level. If you have ClimateLineAir heated air tubing, see the ClimateLineAir user guide.
<b>I am getting droplets of water on my nose, in the mask and air tubing</b> Humidity level may be set too high.	Adjust the Humidity Level. If you have ClimateLineAir heated air tubing, see the ClimateLineAir user guide.
<b>My mouth is very dry and uncomfortable</b> Air may be escaping through your mouth.	Increase the Humidity Level. You may need a chin strap to keep your mouth closed or a full face mask.
<b>Air pressure in my mask seems too high (it feels like I am getting too much air)</b> Ramp may be turned off.	Use the Ramp Time option.
<b>Air pressure in my mask seems too low (it feels like I am not getting enough air)</b> Ramp may be in progress  .	Wait for air pressure to build up or turn Ramp Time off.
Ramp Down may be in progress  .	Press Start/Stop to stop therapy then press Start/Stop to restart and continue therapy.
<b>My screen is black</b> Backlight on the screen may have turned off. It turns off automatically after a short period of time. Power may not be connected.	Press Home or the dial to turn it back on. Connect the power supply and make sure the plug is fully inserted.
<b>I have stopped therapy, but the device is still blowing air</b> Device is cooling down.	Device blows a small amount of air in order to avoid condensation in the air tubing. It will stop automatically after 20 minutes.

Problem/possible cause	Solution
<b>My humidifier is leaking</b>	
Humidifier may not be assembled correctly.	Check for damage and reassemble the humidifier correctly.
Humidifier may be damaged or cracked.	Contact your care provider for a replacement.
<b>My therapy data has not been sent to my care provider</b>	
Power may not be connected.	Connect the power supply and make sure the plug is fully inserted.
Wireless coverage may be poor.	Make sure that the device is placed where there is coverage (ie, on your bedside table, not in a drawer or on the floor). The Wireless signal strength icon  indicates good coverage when all bars are displayed, and poor coverage when fewer bars are displayed.
The No wireless connection icon  is displayed on the top right of the screen. no wireless network available.	Make sure that the device is placed where there is coverage (ie, on your bedside table, not in a drawer or on the floor). If instructed to do so, send the SD card to your care provider. The SD card also contains your therapy data.
Device may be in Airplane Mode.	Turn off Airplane Mode, see Travelling by plane.
Data transfer is not enabled for your device.	Talk to your care provider about your settings.
<b>My screen and buttons are flashing</b>	
Software upgrade is in progress.	Software upgrade takes approximately 10 minutes to complete.

## Device messages

Device message/possible cause	Solution
<b>High leak detected, check your water tub, tub seal or side cover</b>	
Humidifier may not be inserted properly.	Make sure the humidifier is correctly inserted.
Humidifier seal may not be inserted properly.	Open the humidifier and make sure that the seal is correctly inserted.
<b>High leak detected, connect your tubing</b>	
Air tubing may not be connected properly.	Make sure the air tubing is firmly connected at both ends.
Mask may be fitted incorrectly.	Make sure your mask is fitted correctly. See your mask user guide for fitting instructions or use the Mask Fit function to check your mask fit and seal.
<b>Tubing blocked, check your tubing</b>	
Air tubing may be blocked.	Check the air tubing and remove any blockages. Press the dial to clear the message and then press Start/Stop to restart the device.

Device message/possible cause	Solution
<b>SD card error, remove your card and press Start to begin therapy</b>	
SD card may not be inserted correctly.	Remove and reinsert the SD card.
<b>Read only card, please remove, unlock and re-insert SD card</b>	
SD card switch may be in the lock (read-only) position.	Move the switch on the SD Card from the lock position  to the unlock position  and then re-insert it.
<b>System fault, refer to user guide, Error 004</b>	
Device may have been left in a hot environment.	Allow to cool before re-use. Disconnect the power supply and then reconnect it to restart the device.
Air filter may be blocked.	Check the air filter and replace it if there are any blockages. Disconnect the power supply and then reconnect it to restart the device.
Air tubing may be blocked.	Check the air tubing and remove any blockages. Press the dial to clear the message and then press Start/Stop to restart the device.
There may be water in the air tubing.	Empty the water from the air tubing. Disconnect the power supply and then reconnect it to restart the device.
<b>All other error messages, for example, System fault, refer to user guide, Error 0XX</b>	
An unrecoverable error has occurred on the device.	Contact your care provider. Do not open the device.



## Reassembling parts

Some parts of your device are designed to easily come off in order to avoid damage to the parts or the device. You can easily reassemble them as described below.

### To insert the humidifier seal:

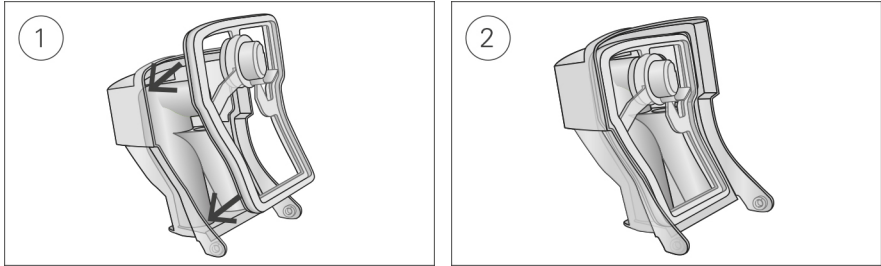

1. Place the seal into the lid.
2. Press down along all edges of the seal until it is firmly in place.

### To reassemble the humidifier lid:

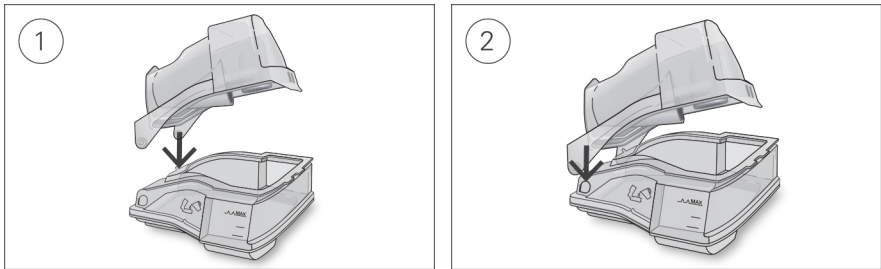

1. Insert one side of the lid into the pivot hole of the base.
2. Slide the other side down the ridge until it clicks into place.

## General warnings and cautions

### WARNING

- Make sure that you arrange the air tubing so that it will not twist around the head or neck.
- Make sure the power cord and plug are in good condition and the equipment is not damaged.
- Keep the power cord away from hot surfaces.
- If you notice any unexplained changes in the performance of the device, if it is making unusual sounds, if the device or the power supply are dropped or mishandled, or if the enclosure is broken, discontinue use and contact your care provider or your ResMed Service Centre.
- Do not open or modify the device. There are no user serviceable parts inside. Repairs and servicing should only be performed by an authorised ResMed service agent.
- Beware of electrocution. Do not immerse the device, power supply or power cord in water. If liquids are spilled into or onto the device, unplug the device and let the parts dry. Always unplug the device before cleaning and make sure that all parts are dry before plugging it back in.
- Supplemental oxygen must not be used while smoking or in the presence of an open flame.
- Always make sure that the device is turned on and airflow generated before the oxygen supply is turned on. Always turn the oxygen supply off before the device is turned off, so that unused oxygen does not accumulate within the device enclosure and create a risk of fire.
- Do not perform any maintenance tasks while the device is in operation.
- The device should not be used adjacent to or stacked with other equipment. If adjacent or stacked use is necessary, the device should be observed to verify normal operation in the configuration in which it will be used.
- The use of accessories other than those specified for the device is not recommended. They may result in increased emissions or decreased immunity of the device.
- Regularly check the antibacterial filter for signs of moisture or other contaminants, particularly during nebulization or humidification. Failure to do so could result in increased breathing system resistance.

### CAUTION

- Use only ResMed parts and accessories with the device. Non-ResMed parts may reduce the effectiveness of the treatment and/or damage the device.
- Use only vented masks recommended by ResMed or by the prescribing doctor with this device. Fitting the mask without the device blowing air can result in rebreathing of exhaled air. Make sure that the mask vent holes are kept clear and unblocked to maintain the flow of the fresh air into the mask.
- Be careful not to place the device where it can be bumped or where someone is likely to trip over the power cord.
- Blocking the air tubing and/or air inlet of the device while in operation could lead to overheating of the device.
- Keep the area around the device dry, clean and clear of anything (eg, clothes or bedding) that could block the air inlet or cover the power supply unit.
- Do not place the device on its side as water might get into the device.
- Incorrect system setup may result in incorrect mask pressure reading. Ensure the system is correctly set up.

- Do not use bleach, chlorine, alcohol, or aromatic-based solutions, moisturising or antibacterial soaps or scented oils to clean the device, the humidifier or air tubing. These solutions may cause damage or affect the humidifier performance and reduce the life of the products.
- If you use the humidifier, always place the device on a level surface lower than your head to prevent the mask and air tubing from filling with water.
- Leave the humidifier to cool for ten minutes before handling to allow the water to cool and to make sure that the humidifier is not too hot to touch.
- Make sure that the humidifier is empty before transporting the device.

**Note:** The device is not intended to be operated by persons (including children) with reduced physical, sensory or mental capabilities without adequate supervision by a person responsible for the patient's safety.

## Technical specifications

Units are expressed in cm H<sub>2</sub>O and hPa. 1 cm H<sub>2</sub>O is equal to 0.98 hPa.

### 90W power supply unit

AC input range:	100–240V, 50–60Hz 1.0–1.5A, Class II 115V, 400Hz 1.5A, Class II (nominal for aircraft use)
DC output:	24V $\overline{\text{---}}$ 3.75A
Typical power consumption:	53W (57VA)
Peak power consumption:	104W (108VA)

### Environmental conditions

Operating temperature:	+5°C to +35°C <b>Note:</b> The air flow for breathing produced by this therapy device can be higher than the temperature of the room. Under extreme ambient temperature conditions (40°C) the device remains safe.
Operating humidity:	10 to 95% relative humidity, non-condensing
Operating altitude:	Sea level to 8,500' (2,591 m); air pressure range 1013 hPa to 738 hPa
Storage and transport temperature:	-20°C to +60°C
Storage and transport humidity:	5 to 95% relative humidity, non-condensing

### Electromagnetic compatibility

The Lumis complies with all applicable electromagnetic compatibility requirements (EMC) according to IEC 60601-1-2:2014, for residential, commercial and light industry environments. It is recommended that mobile communication devices are kept at least 1 m away from the device.

Information regarding the electromagnetic emissions and immunity of this ResMed device can be found on [www.resmed.com/downloads/devices](http://www.resmed.com/downloads/devices)

### IEC 60601-1:2005+A1:2012 classification

Class II (double insulation), Type BF, Ingress protection IP22.

### Sensors

Pressure sensor:	Internally located at device outlet, analogue gauge pressure type, -5 to +45 cm H <sub>2</sub> O (-5 to +45 hPa)
Flow sensor:	Internally located at device inlet, digital mass flow type, -70 to +180 L/min

### Maximum single fault steady pressure

Device will shut down in the presence of a single fault if the steady state pressure exceeds:

30 cm H<sub>2</sub>O (30 hPa) for more than 6 sec or 40 cm H<sub>2</sub>O (40 hPa) for more than 1 sec.

## Sound

Pressure level measured according to ISO 80601-2-70:2015 (CPAP mode):

SlimLine: 25 dBA with uncertainty of 2 dBA

Standard: 25 dBA with uncertainty of 2 dBA

SlimLine or Standard and humidification: 27 dBA with uncertainty of 2 dBA

Power level measured according to ISO 80601-2-70:2015 (CPAP mode):

SlimLine: 33 dBA with uncertainty of 2 dBA

Standard: 33 dBA with uncertainty of 2 dBA

SlimLine or Standard and humidification: 35 dBA with uncertainty of 2 dBA

Declared dual-number noise emission values in accordance with ISO 4871:1996.

---

## Physical - device and humidifier

Dimensions (H x W x D): 116 mm x 255 mm x 150 mm

Air outlet (complies with ISO 5356-1:2004): 22 mm

Weight (device and cleanable humidifier): 1268 g

Housing construction: Flame retardant engineering thermoplastic

Water capacity: To maximum fill line 380 mL

Cleanable humidifier - material: Injection moulded plastic, stainless steel and silicone seal

---

## Temperature

Maximum heater plate: 68°C

Cut-out: 74°C

Maximum gas temperature: ≤ 41°C

---

## Air filter

Standard: Material: Polyester non woven fibre  
Average arrestance: >75% for ~7 micron dust

Hypoallergenic: Material: Acrylic and polypropylene fibres in a polypropylene carrier  
Efficiency: >98% for ~7-8 micron dust; >80% for ~0.5 micron dust

---

## Aircraft use

ResMed confirms that device meets the Federal Aviation Administration (FAA) requirements (RTCA/DO-160, section 21, category M) for all phases of air travel.

---

## Wireless module

Technology used: 3G GSM, 2G GSM

It is recommended that the device is a minimum distance of 2 cm from the body during operation. Not applicable to masks, tubes or accessories

---

## Declaration of Conformity (DoC to the R&TTE Directive)

ResMed declares that the Lumis device is in compliance with the essential requirements and other relevant provisions of Directive 1999/5/EC. A copy of the declaration of conformity (DoC) can be found on [www.ResMed.com/ProductSupport](http://www.ResMed.com/ProductSupport).

---

## Operating pressure range

S, ST, T, PAC, iVAPS: 2 to 25 cm H<sub>2</sub>O (2 to 25 hPa)

CPAP: 4 to 20 cm H<sub>2</sub>O (4 to 20 hPa)

---

## Supplemental oxygen

Maximum flow: 15 L/min (S, ST, T, PAC, CPAP), 4 L/min (iVAPS)

---

## Pneumatic flow path

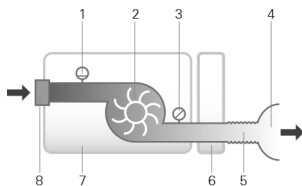

1. Flow sensor
2. Blower
3. Pressure sensor
4. Mask
5. Air tubing
6. Humidifier
7. Device
8. Inlet filter

## Design life

Device, power supply unit:	5 years
Cleanable humidifier:	2.5 years
Air tubing:	6 months

## General

The patient is an intended operator.

## Humidifier performance

Mask Pressure cm H <sub>2</sub> O (hPa)	Nominal RH output %		Nominal system output AH <sup>1</sup> , BTPS <sup>2</sup>	
	Setting 4	Setting 8	Setting 4	Setting 8
3	85	100	6	>10
4	85	100	6	>10
10	85	100	6	>10
20	85	90	6	>10
25	85	90	6	>10

<sup>1</sup> AH - Absolute Humidity in mg/L

<sup>2</sup> BTPS - Body Temperature Pressure Saturated

## Air tubing

Air tubing	Material	Length	Inner diameter
ClimateLineAir	Flexible plastic and electrical components	2 m	15 mm
ClimateLineAir Oxy	Flexible plastic and electrical components	1.9 m	19 mm
SlimLine	Flexible plastic	1.8 m	15 mm
Standard	Flexible plastic	2 m	19 mm
3 m	Flexible plastic	3 m	19 mm

Heated air tubing temperature cut-out:  $\leq 106^{\circ}\text{F}$  ( $\leq 41^{\circ}\text{C}$ )

## Notes:

- The manufacturer reserves the right to change these specifications without notice.
- The electrical connector end of the heated air tubing is only compatible with the air outlet at the device end and should not be fitted to the mask.
- Do not use electrically conductive or antistatic air tubing.
- The temperature and relative humidity settings displayed are not measured values.

## Displayed values

Value	Range	Display resolution
Pressure sensor at air outlet:		
Mask pressure	2–25 cm H <sub>2</sub> O (2–25 hPa)	0.1 cm H <sub>2</sub> O (0.1 hPa)
Flow derived values:		
Leak	0–120 L/min	1 L/min
Tidal volume	0–4000 mL	1 mL
Respiratory rate	0–50 BPM	1 BPM
Minute ventilation	0–30 L/min	0.1 L/min
Ti	0.1–4.0 sec	0.1 sec
I:E ratio	1:100–2:1	0.1
Value	Accuracy <sup>1</sup>	
Pressure measurement <sup>1</sup> :		
Mask pressure <sup>2</sup>	±[0.5 cm H <sub>2</sub> O (0.5 hPa) + 4% of measured value]	
Flow and flow derived values <sup>1</sup> :		
Flow	±6 L/min or 10% of reading, whichever is greater, at 0 to 150 L/min positive flow	
Leak <sup>2</sup>	±12 L/min or 20% of reading, whichever is greater, 0 to 60 L/min	
Tidal volume <sup>2,3</sup>	±20%	
Respiratory rate <sup>2,3</sup>	±1.0 BPM	
Minute ventilation <sup>2,3</sup>	±20%	

<sup>1</sup> Results are expressed at STPD (Standard Temperature and Pressure, Dry).

<sup>2</sup> Accuracy may be reduced by the presence of leaks, supplemental oxygen, tidal volumes <100 mL or minute ventilation <3 L/min.

<sup>3</sup> Measurement accuracy verified as per EN ISO 10651-6:2009 for Home Care Ventilatory Support Devices (Figure 101 and Table 101) using nominal ResMed mask vent flows.

## Measurement system uncertainties

In accordance with ISO 80601-2-70:2015 the measurement uncertainty of the manufacturer's test equipment is:

For measures of flow	± 1.5 L/min or ± 2.7% of reading (whichever is greater)
For measures of volume (< 100 mL)	± 5 mL or 6% of reading (whichever is greater)
For measures of volume (≥ 100 mL)	± 20 mL or 3% of reading (whichever is greater)
For measures of pressure	± 0.15 cm H <sub>2</sub> O (0.15 hPa)
For measures of time	± 10 ms

## Pressure accuracy

### Maximum static pressure variation at 10 cm H<sub>2</sub>O (10 hPa) according to ISO 80601-2-70:2015

	Standard air tubing	SlimLine air tubing
Without humidification	± 0.5 cm H <sub>2</sub> O (± 0.5 hPa)	± 0.5 cm H <sub>2</sub> O (± 0.5 hPa)
With humidification	± 0.5 cm H <sub>2</sub> O (± 0.5 hPa)	± 0.5 cm H <sub>2</sub> O (± 0.5 hPa)

### Maximum dynamic pressure variation according to ISO 80601-2-70:2015

Device without humidification and Standard air tubing / Device with humidification and Standard air tubing	10 BPM	15 BPM	20 BPM
Pressure [cm H <sub>2</sub> O (hPa)]			
4	0.5 / 0.5	0.5 / 0.5	0.8 / 0.8
8	0.5 / 0.5	0.5 / 0.5	0.8 / 0.8
12	0.5 / 0.5	0.5 / 0.5	0.8 / 0.8
16	0.5 / 0.5	0.5 / 0.5	0.8 / 0.8
20	0.5 / 0.5	0.5 / 0.5	0.8 / 0.8
25	0.3 / 0.3	0.5 / 0.4	0.7 / 0.7

Device without humidification and SlimLine air tubing / Device with humidification and SlimLine air tubing

Pressure [cm H <sub>2</sub> O (hPa)]	10 BPM	15 BPM	20 BPM
4	0.5 / 0.5	0.5 / 0.5	0.8 / 0.8
8	0.5 / 0.5	0.5 / 0.5	0.8 / 0.8
12	0.5 / 0.5	0.5 / 0.5	0.8 / 0.8
16	0.5 / 0.5	0.5 / 0.5	0.8 / 0.8
20	0.5 / 0.5	0.5 / 0.5	0.8 / 0.8
25	0.4 / 0.3	0.6 / 0.5	0.8 / 0.8

### Pressure accuracy - bilevel

Maximum dynamic pressure variation according to ISO 80601-2-70:2015.

Device without humidification and Standard air tubing / Device with humidification and Standard air tubing

Breath rate	Inspiratory pressure (cm H <sub>2</sub> O [hPa]) (Means, Standard Deviations)				
	6	10	16	21	25
10 BPM	-0.09, 0.01 / -0.22, 0.01	-0.01, 0.07 / -0.22, 0.01	0.07, 0.05 / -0.24, 0.01	-0.03, 0.09 / -0.29, 0.03	0.12, 0.01 / -0.26, 0.02
15 BPM	0.02, 0.08 / -0.22, 0.01	0.12, 0.01 / -0.22, 0.01	0.15, 0.01 / -0.26, 0.01	0.15, 0.01 / -0.31, 0.02	0.16, 0.12 / -0.30, 0.02
20 BPM	0.17, 0.01 / -0.23, 0.01	0.21, 0.01 / -0.28, 0.01	0.25, 0.01 / -0.34, 0.01	0.21, 0.17 / -0.38, 0.02	0.32, 0.02 / -0.40, 0.03
Breath rate	Expiratory pressure (cm H <sub>2</sub> O [hPa]) (Means, Standard Deviations)				
	2	6	12	17	21
10 BPM	-0.14, 0.01 / -0.27, 0.01	-0.16, 0.01 / -0.29, 0.02	-0.11, 0.10 / -0.34, 0.02	-0.16, 0.05 / -0.33, 0.01	-0.17, 0.05 / -0.33, 0.02
15 BPM	-0.16, 0.01 / -0.25, 0.01	-0.20, 0.01 / -0.33, 0.02	-0.20, 0.05 / -0.35, 0.01	-0.21, 0.05 / -0.38, 0.02	-0.23, 0.08 / -0.38, 0.02
20 BPM	-0.27, 0.01 / -0.37, 0.01	-0.26, 0.02 / -0.34, 0.01	-0.25, 0.01 / -0.38, 0.01	-0.29, 0.01 / -0.43, 0.02	-0.31, 0.01 / -0.45, 0.03

Device without humidification and SlimLine air tubing / Device with humidification and SlimLine air tubing

Breath rate	Inspiratory pressure (cm H <sub>2</sub> O [hPa]) (Means, Standard Deviations)				
	6	10	16	21	25
10 BPM	-0.26, 0.01 / -0.52, 0.01	-0.25, 0.02 / -0.53, 0.02	-0.24, 0.02 / -0.53, 0.01	-0.25, 0.02 / -0.54, 0.02	-0.20, 0.02 / -0.51, 0.02
15 BPM	-0.26, 0.01 / -0.51, 0.01	-0.25, 0.01 / -0.54, 0.01	-0.26, 0.01 / -0.56, 0.01	-0.31, 0.03 / -0.58, 0.02	-0.30, 0.05 / -0.60, 0.03
20 BPM	-0.25, 0.02 / -0.52, 0.01	-0.29, 0.02 / -0.58, 0.01	-0.34, 0.02 / -0.62, 0.01	-0.36, 0.02 / -0.67, 0.02	-0.36, 0.03 / -0.69, 0.02
Breath rate	Expiratory pressure (cm H <sub>2</sub> O [hPa]) (Means, Standard Deviations)				
	2	6	12	17	21
10 BPM	-0.28, 0.01 / -0.43, 0.01	-0.30, 0.03 / -0.50, 0.01	-0.30, 0.01 / -0.54, 0.01	-0.33, 0.01 / -0.58, 0.01	-0.34, 0.01 / -0.60, 0.02
15 BPM	-0.24, 0.02 / -0.37, 0.01	-0.29, 0.02 / -0.47, 0.01	-0.35, 0.01 / -0.55, 0.01	-0.38, 0.01 / -0.62, 0.02	-0.42, 0.02 / -0.66, 0.01
20 BPM	0.05, 0.21 / -0.38, 0.01	-0.31, 0.02 / -0.50, 0.02	-0.37, 0.02 / -0.57, 0.02	-0.43, 0.02 / -0.65, 0.02	-0.48, 0.02 / -0.68, 0.02

Note: The table above is based on data that covers between 60.1 and 88.8% of the inspiratory phase and 66.1 and 93.4% of the expiratory phase durations. These data time slots start immediately after the initial transient overshoot/undershoot periods and end at the point that flow diminishes to an equivalent absolute value of its starting point, towards the end of the breath phases (this corresponds to the % ranges of values given immediately above).

























## Flow (maximum) at set pressures

The following are measured accordingly to ISO 80601-2-70:2015 at the end of the specified air tubing:

Pressure cm H <sub>2</sub> O (hPa)	Lumis and Standard L/min	Lumis, humidification and Standard L/min	Lumis and SlimLine L/min	Lumis, humidification and ClimateLineAir L/min
4	180	143	162	151
8	168	135	151	142
12	157	136	140	135
16	144	134	128	121
20	131	123	117	109
25	120	115	96	84

## Symbols

The following symbols may appear on the product or packaging.

 Read instructions before use.  Indicates a warning or caution.  Follow instructions before use.  Manufacturer.  European Authorised Representative.  Batch code.  Catalogue number.  Serial number.  Device number.  On / Off.  Device weight.   
**IP22** Protected against finger sized objects and against dripping water when tilted up to 15 degrees from specified orientation.  Direct current.  Type BF applied part.  Class II equipment.   
 Humidity limitation.  Temperature limitation.  Non-ionising radiation.  China pollution control logo 1.  China pollution control logo 2. **Rx Only** Prescription only (In the US, Federal law restricts these devices to sale by or on the order of a physician).  **MAX** Maximum water level.  Use distilled water only.  Operating altitude.  Atmospheric pressure limitation.  Complies with RTCA DO-160 section 21, category M.



### Environmental information

This device should be disposed of separately, not as unsorted municipal waste. To dispose of your device, you should use appropriate collection, reuse and recycling systems available in your region. The use of these collection, reuse and recycling systems is designed to reduce pressure on natural resources and prevent hazardous substances from damaging the environment.

If you need information on these disposal systems, please contact your local waste administration. The crossed-bin symbol invites you to use these disposal systems. If you require information on collection and disposal of your ResMed device please contact your ResMed office, local distributor or go to [www.resmed.com/environment](http://www.resmed.com/environment).

## Servicing

The Lumis device is intended to provide safe and reliable operation when operated in accordance with the instructions provided by ResMed. ResMed recommends that the Lumis device be inspected and serviced by an authorised ResMed Service Centre if there is any sign of wear or concern with device function. Otherwise, service and inspection of the products generally should not be required during their design life.



## Limited warranty

ResMed Ltd (hereafter 'ResMed') warrants that your ResMed product shall be free from defects in material and workmanship from the date of purchase for the period specified below.

Product	Warranty period
<ul style="list-style-type: none"><li>• Mask systems (including mask frame, cushion, headgear and tubing)—excluding single-use devices</li><li>• Accessories—excluding single-use devices</li><li>• Flex-type finger pulse sensors</li><li>• Humidifier water tubs</li></ul>	90 days
<ul style="list-style-type: none"><li>• Batteries for use in ResMed internal and external battery systems</li></ul>	6 months
<ul style="list-style-type: none"><li>• Clip-type finger pulse sensors</li><li>• CPAP and bilevel device data modules</li><li>• Oximeters and CPAP and bilevel device oximeter adapters</li><li>• Humidifier cleanable water tubs</li><li>• Titration control devices</li></ul>	1 year
<ul style="list-style-type: none"><li>• CPAP, bilevel and ventilation devices (including external power supply units)</li><li>• Humidifiers</li><li>• Battery accessories</li><li>• Portable diagnostic/screening devices</li></ul>	2 years

This warranty is only available to the initial consumer. It is not transferable.

If the product fails under conditions of normal use, ResMed will repair or replace, at its option, the defective product or any of its components.

This Limited Warranty does not cover: a) any damage caused as a result of improper use, abuse, modification or alteration of the product; b) repairs carried out by any service organisation that has not been expressly authorised by ResMed to perform such repairs; and c) any damage or contamination due to cigarette, pipe, cigar or other smoke.

Warranty is void on product sold, or resold, outside the region of original purchase.

Warranty claims on defective product must be made by the initial consumer at the point of purchase.

This warranty replaces all other expressed or implied warranties, including any implied warranty of merchantability or fitness for a particular purpose. Some regions or states do not allow limitations on how long an implied warranty lasts, so the above limitation may not apply to you.

ResMed shall not be responsible for any incidental or consequential damages claimed to have resulted from the sale, installation or use of any ResMed product. Some regions or states do not allow the exclusion or limitation of incidental or consequential damages, so the above limitation may not apply to you.

This warranty gives you specific legal rights, and you may also have other rights which vary from region to region. For further information on your warranty rights, contact your local ResMed dealer or ResMed office.

## Further information

If you have any questions or require additional information on how to use the device, contact your care provider.



**ResMed Ltd**  
1 Elizabeth Macarthur Drive  
Bella Vista NSW 2153 Australia

**DISTRIBUTED BY**  
ResMed Corp 9001 Spectrum Center Boulevard San Diego CA 92123 USA  
**EC|REP** ResMed (UK) Ltd 96 Jubilee Ave Milton Park Abingdon Oxfordshire OX14 4RW UK

See [www.ResMed.com](http://www.ResMed.com) for other ResMed locations worldwide. For patent and other intellectual property information, see [www.ResMed.com/ip](http://www.ResMed.com/ip). Air10, Lumis, ClimateLine, SlimLine, HumidAir, SmartStart and VPAP are trademarks of ResMed Ltd. ClimateLine, SlimLine, SmartStart and VPAP are registered in U.S. Patent and Trademark Office. SD Logo is a trademark of SD-3C, LLC.  
© 2016 ResMed Ltd. 288117/1 2016-05

ResMed.com



288117